

14ft PRO II ENCLOSED TRAILER

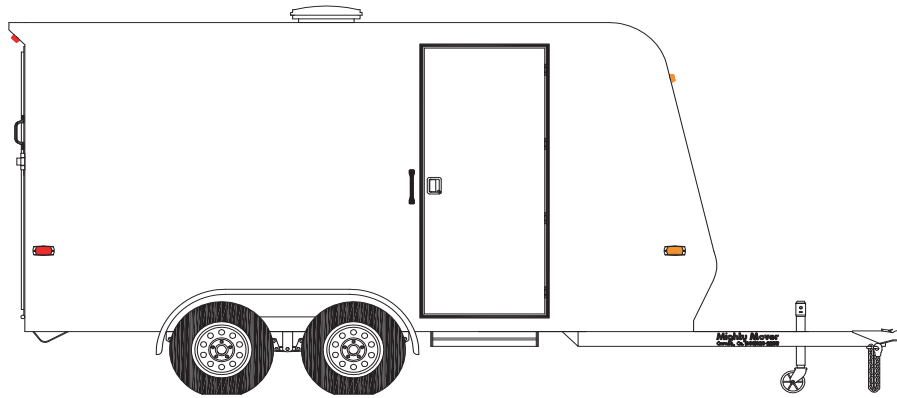

BODY LENGTH	14ft 0in	G.V.W.R. (lbs)	5,000lbs	INTERIOR LENGTH	13ft 9in
BODY WIDTH	8ft 0in	G.A.W.R. (lbs)	7,000lbs	INTERIOR HEIGHT	6ft 6in
OVERALL LENGTH	19ft 0in	CURB WEIGHT (lbs)	2,200lbs	INTERIOR WIDTH	7ft 10in between side walls
OVERALL WIDTH	8ft 4in	PAYLOAD (lbs)	2,800lbs	INTERIOR WIDTH	7ft 8in between bumper rails
OVERALL HEIGHT	8ft 11in	HITCH WEIGHT	10 - 15%	INTERIOR WIDTH	6ft 8in between wheel wells
DECK HEIGHT	22in	CUBIC CAPACITY	710cu ft	REAR DOOR HEIGHT	6ft 1in
BALL HEIGHT	17in	HITCH	2in ball coupler	REAR DOOR WIDTH	7ft 9in

- 5,000LBS.G.V.W. RATING
- 53IN LONG TONGUE - FRONT CROSSMEMBER TO THE CENTER OF THE BALL
- HEAVY DUTY 2IN BALL COUPLER
- HEAVY DUTY DUAL SAFETY CHAINS WITH HOOKS (DOT STANDARD)
- FULLY COMPLIANT D.O.T. REGULATION LIGHT PACKAGE
- LIGHTING COMPLIES WITH ALL APPLICABLE REQUIREMENTS PRESCRIBED BY FMVSS/CMVSS 108
- 7-WAY FLAT PIN TRAILER ELECTRICAL CONNECTOR (TOW PACKAGE STANDARD)
- HEAVY DUTY 1,500LBS CAPACITY SWIVEL LANDING JACK WITH CASTER
- WHITE MODULAR STYLE 14"x 6" WHEELS WITH 5 ON 4-1/2" BOLT CIRCLE
- ST205/75D-14" LOAD RANGE "C" TIRES
- TANDEM 3,500LBS STRAIGHT AXLES WITH LEAF SPRING SUSPENSION
- 10"x 2-1/4" ELECTRIC BRAKES ON THE REAR AXLE
- EMERGENCY BREAK-AWAY SYSTEM
- BOLTED ON, PAINTED STEEL ROUNDED FENDERS
- WHITE .040 PRE-FINISHED EXTERIOR SMOOTH ALUMINUM SKIN, BONDED - NO FASTENERS
- WHITE 3 MIL VINYL COATED WALLS AND CEILING
- 30"x 72" RV STYLE SIDE ENTRY DOOR WITH FLUSH LATCH
- SLIDE-OUT SIDE DOOR CONVENIENCE STEP
- BRIGHT ALUMINUM DIAMOND PLATE OR STAINLESS STEEL FRONT ROCK GUARD
- WHITE SMOOTH FULL WIDTH SPRING ASSISTED REAR RAMP DOOR
- ALUMINUM DIAMOND PLATE RAMP DOOR EDGE PROTECTOR
- ALL STEEL WELDED 4" BOX TUBE MAINFRAME
- 1-1/2"x 1" RECTANGULAR TUBING WALL UPRIGHTS ON 24" CENTERS
- 1-1/2"x 1" RECTANGULAR TUBING ROOF BOWS ON 24" CENTERS
- 3/4" TONGUE & GROOVE PLYWOOD FLOOR WITH MARINE VARNISH
- 1" Sq. TUBING TIE BAR BOTH SIDES WITH 3/8" WELDED TIE DOWN LOOPS
- ONE (1) 12 VOLT INTERIOR DOME LIGHTS WITH WALL SWITCH
- ONE (1) MANUAL CRANK-UP ROOF VENTS
- SPARE TIRE MOUNT (SPARE TIRE AND WHEEL OPTIONAL)

14ft PRO II ENCLOSED TRAILER

POPULAR OPTIONS

- TINTED SLIDER WINDOWS, WITH SCREEN - 22" x 40"
- FULL WIDTH FRONT WORK BENCH
- FULL WIDTH FRONT OVERHEAD CABINET WITH 12VOLT DOME LIGHT
- FULL WIDTH FRONT WORK CENTER - OVERHEAD CABINET, WORK BENCH, LOWER FACING WITH DOUBLE DOORS
- SIDE OVERHEAD CABINETS
- 36" x 72" SIDE ENTRY DOOR EXCHANGE
- 46" x 72" SIDE ENTRY DOOR EXCHANGE
- SIDE RAMP DOOR
- DOUBLE REAR CARGO DOORS
- FLUSH MOUNTED 5,000LBS CAPACITY "D" RING
- REINFORCED WALK-ON ROOF
- UNDER-FLOOR, HINGED LID, STORAGE POD (APPROX: 60" x 22" x 11")
- DOVETAIL
- HEAVY DUTY REAR SKID ROLLERS
- SWING DOWN REAR STABILIZER JACKS
- HEAVY DUTY CRANK DOWN STABILIZER JACKS
- 115V, 30AMP ELECTRICAL SYSTEM WITH PANEL, POWER CORD AND THREE (3) DUPLEX OUTLETS
- 115V, 4FT DOUBLE TUBE FLUORESCENT LIGHT FIXTURES WITH WALL SWITCH
- 115V, GFI PROTECTED EXTERIOR OUTLETS
- 13,500BTU ROOF MOUNTED AIR CONDITIONER WITH HEAT STRIP
- 115V, 500WATT EXTERIOR FLUSH MOUNTED QUARTZ FLOOD LIGHTS WITH WALL SWITCH
- 12V DEEP CYCLE BATTERY WITH PLASTIC CASE
- 12V EXTERIOR FLUSH MOUNTED DOCKING LIGHTS
- 12V EXTERIOR PORCH LIGHT
- 12V HEAVY DUTY ELECTRIC TONGUE JACK
- 12V REAR LOADING LIGHTS WITH WALL SWITCH
- 12V ELECTRIC WINCH WITH WIRED REMOTE
- DRIVE OVER WHEEL WELLS
- RUBBER TORSION AXLE EXCHANGE
- 40GAL FRESH WATER SYSTEM WITH 40GAL TANK, PUMP, SPIGOT, AND BATTERY
- 1-1/8" TONGUE AND GROOVE PLYWOOD DECK EXCHANGE
- BLACK AND WHITE VINYL CHECKERBOARD FLOORING (REQUIRES 1-1/8" PLYWOOD DECK OPTION)
- ROLL-UP RV AWNINGS
- FRONT V-NOSE
- CHROME WHEEL EXCHANGE
- RADIAL TIRE EXCHANGE
- REMOVABLE TONGUE EXCHANGE
- EXTENDED TONGUE
- REST ROOM
- SPARE TIRE AND WHEEL

14ft Pro II Enclosed Trailer

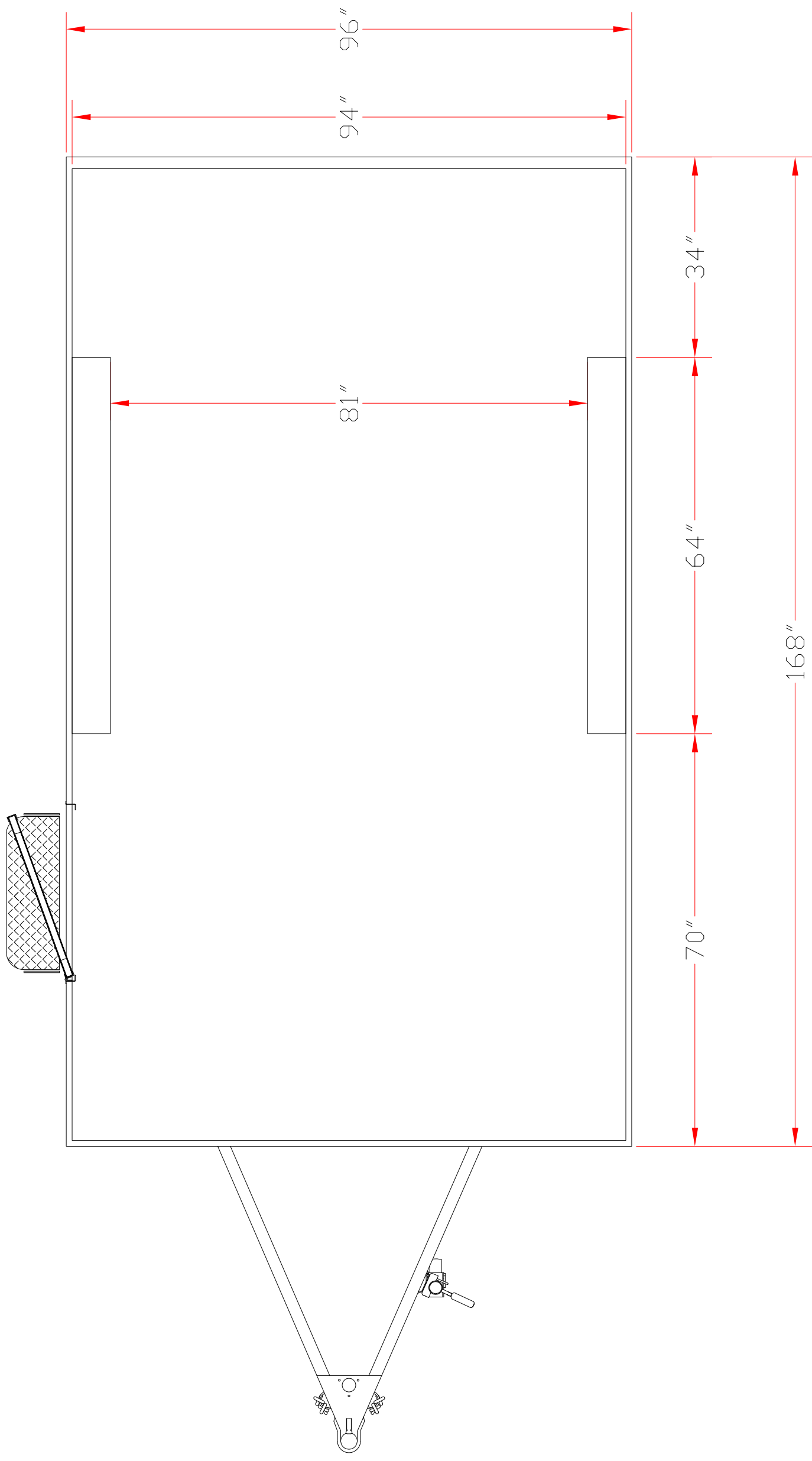

14ft Pro II Enclosed Trailer

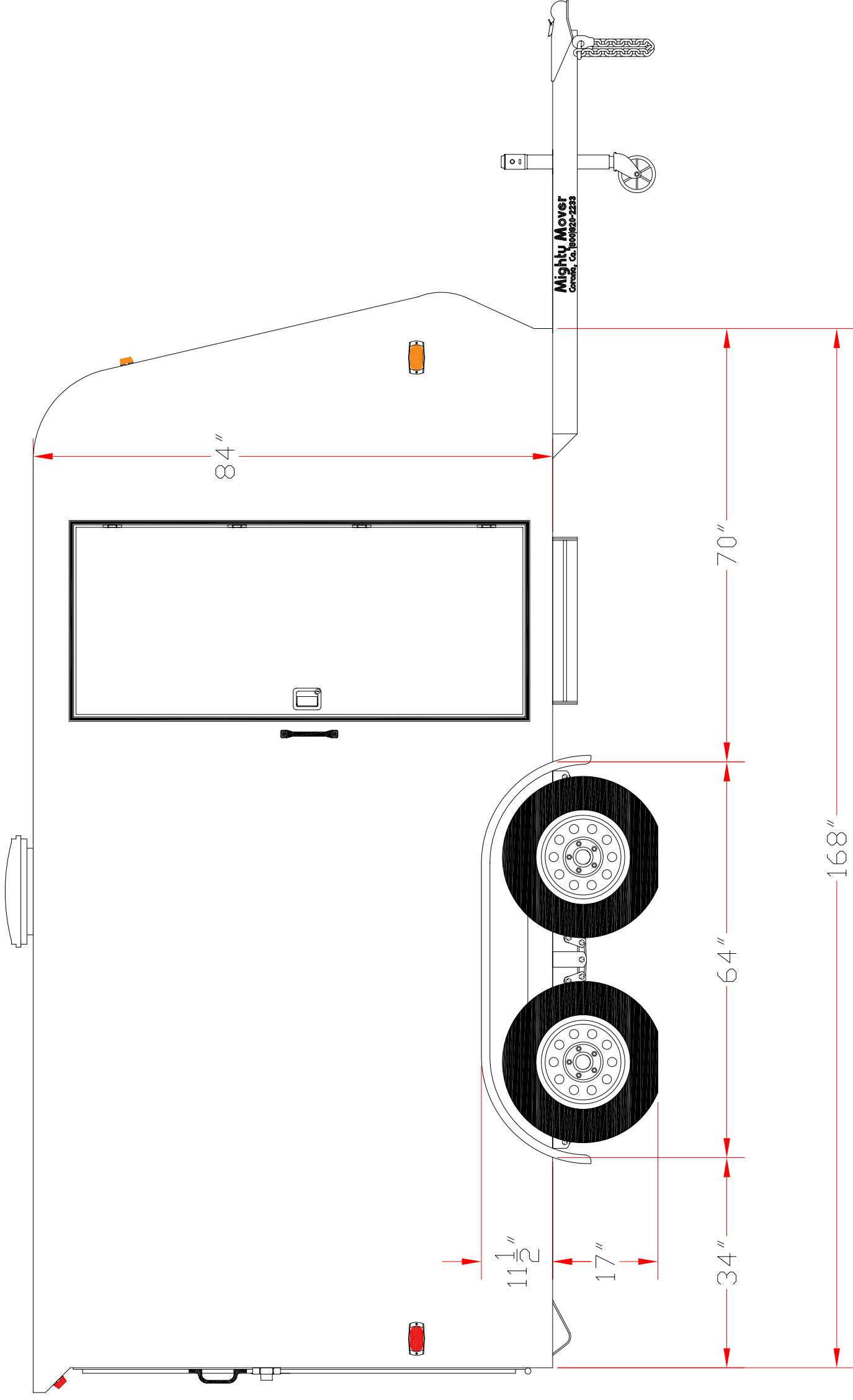

14ft Pro II Enclosed Trailer

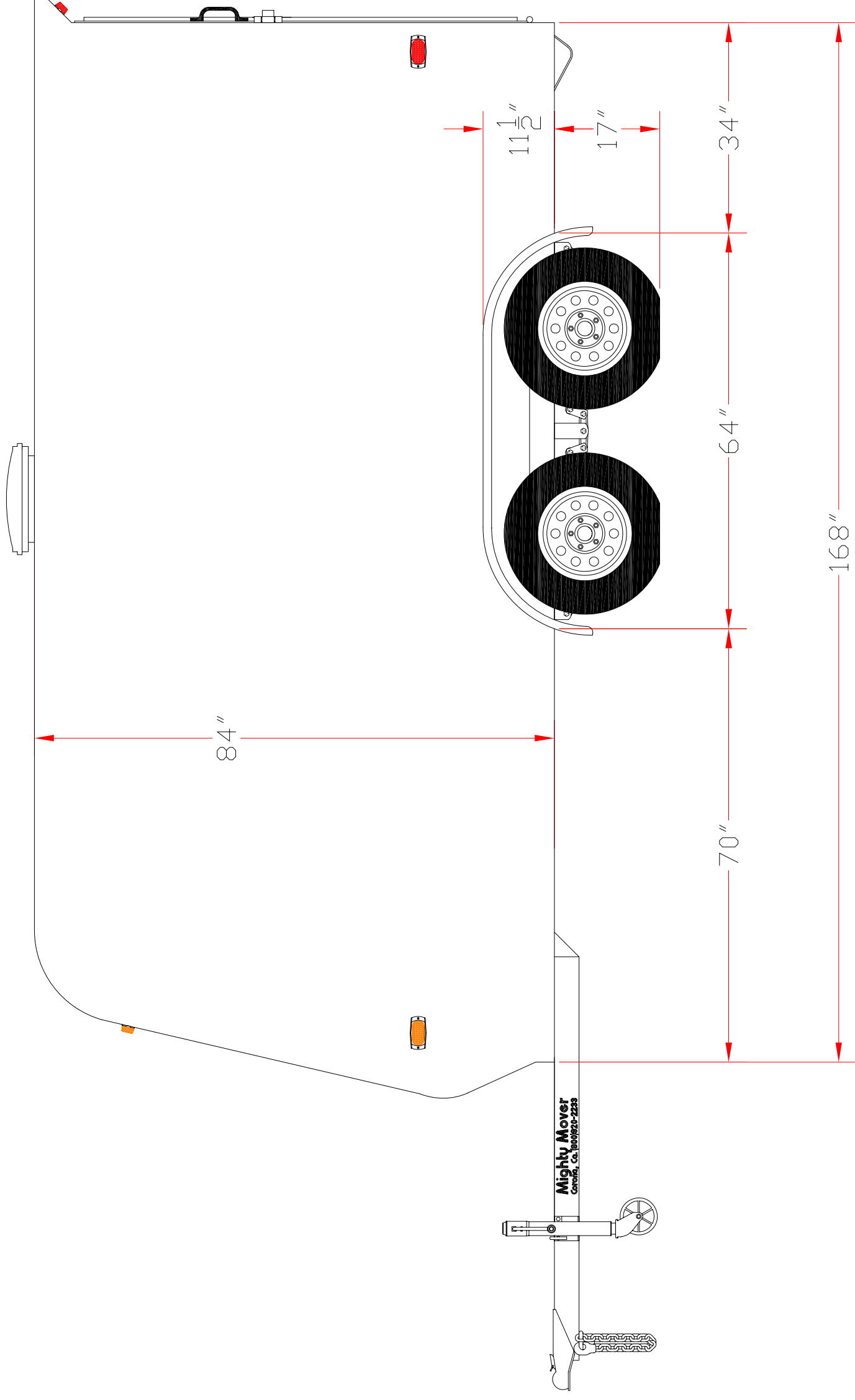

14ft Pro II Enclosed Trailer

